

HAND TOOLS UNSCRAMBLE THE WORDS !

Unscramble the hand tools vocabulary and number the pictures

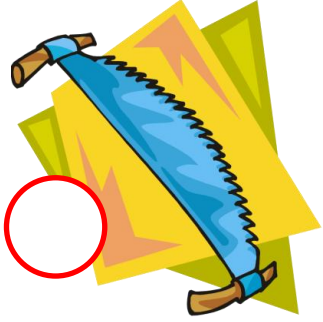

1. marehm _____
2. iedwevcrrrs _____
3. rwchne _____
4. rlpsei _____
5. taep samruee _____
6. rWSCSE _____
7. lsnia _____
8. eax _____
9. vseolh _____
10. tnsu _____
11. owrtel _____
12. pencisr _____
13. tmlale _____
14. asw _____
15. raedld _____
16. pcmal _____

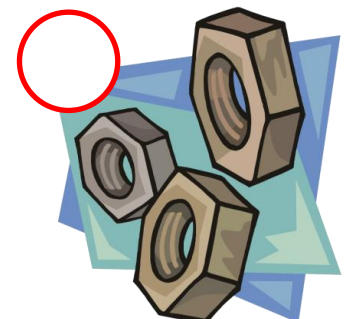
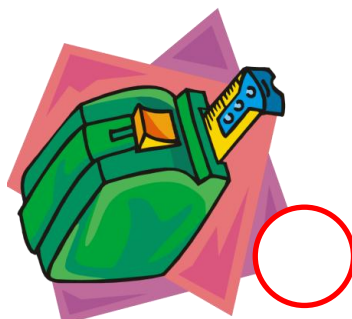
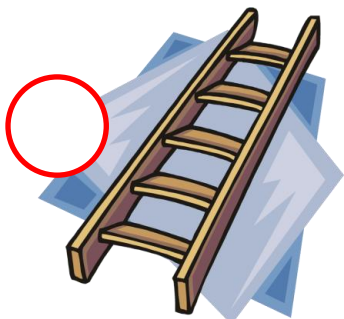
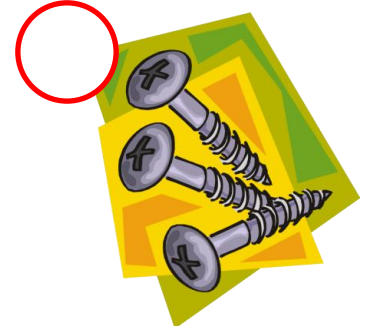

HAND TOOLS UNSCRAMBLE THE WORDS 2

Unscramble the hand tools vocabulary and number the pictures

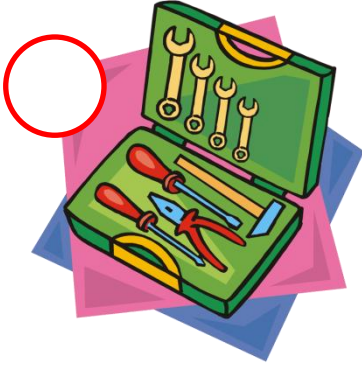
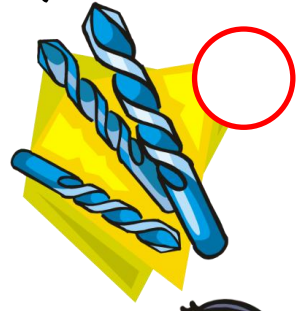
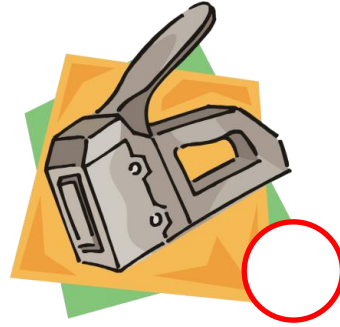

1. udtbeasajl erhncw _____
2. dilrl _____
3. hagnreemesdl _____
4. acahwks _____
5. dlrl bist _____
6. tinap rrleol _____
7. ibnshpurta _____
8. ilfe _____
9. ncawihsa _____
10. ihlcse _____
11. ssgal tucert _____
12. gnnridgi eanicmh _____
13. oloxtob _____
14. lpaset ugn _____
15. drnogseil onir _____
16. thoroclbw _____

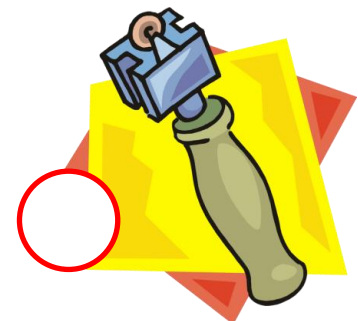
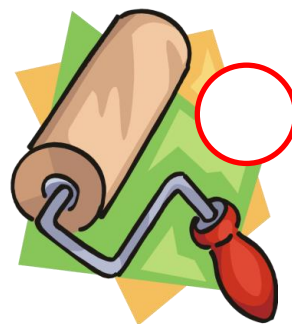
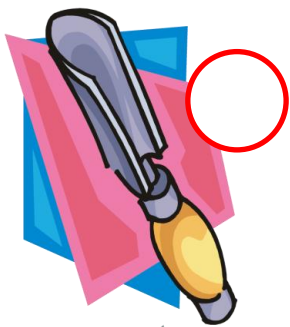
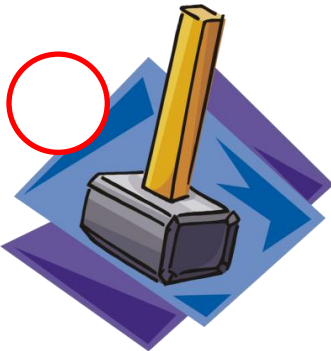
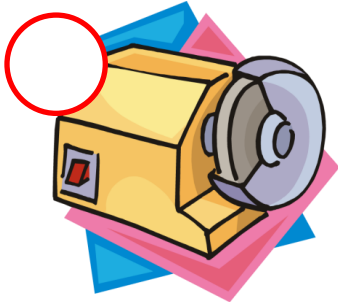
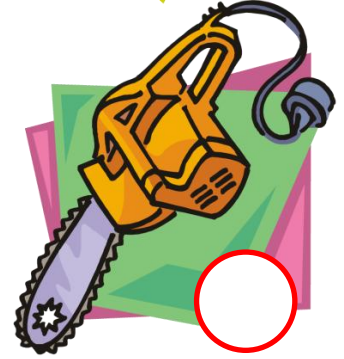

HAND TOOLS UNSCRAMBLE THE WORDS | ANSWER KEY

Unscramble the hand tools vocabulary and number the pictures



14



7



12



1



9

- | | |
|-----------------|--------------|
| 1. marehm | hammer |
| 2. iedwevcrrrs | screwdriver |
| 3. rwchne | wrench |
| 4. rlpsei | pliers |
| 5. taep samruee | tape measure |
| 6. rWSCse | screws |
| 7. lsnia | nails |
| 8. eax | axe |
| 9. vseolh | shovel |
| 10. tnsu | nuts |
| 11. owrtel | trowel |
| 12. pencisr | pincers |
| 13. tmlale | mallet |
| 14. asw | saw |
| 15. raedld | ladder |
| 16. pcmal | clamp |



8



11



3



13

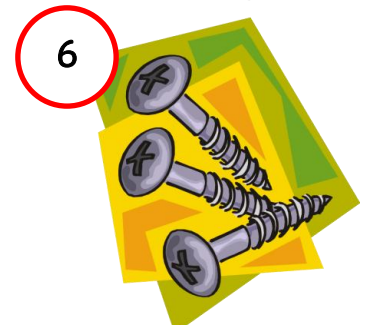

6



16



2

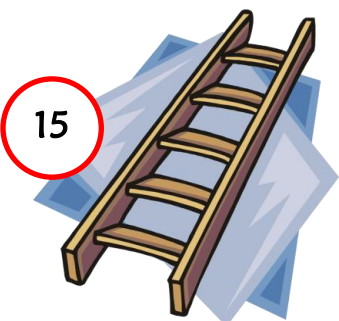

15



5



4

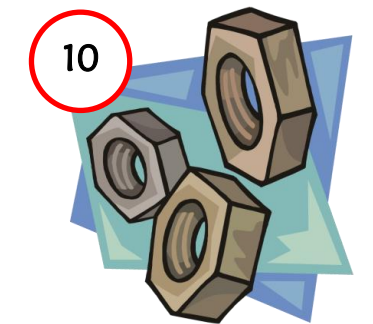

10

HAND TOOLS UNSCRAMBLE THE WORDS 2 ANSWER KEY

Unscramble the hand tools vocabulary and number the pictures

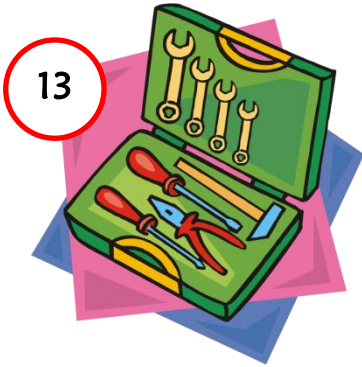
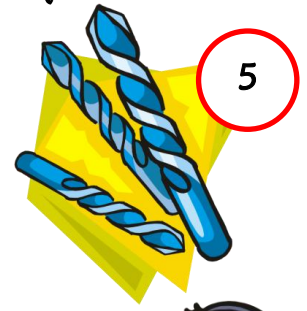

- | | |
|----------------------|-------------------|
| 1. udtbeasajl erhncw | adjustable wrench |
| 2. dilrl | drill |
| 3. hagnreemesdl | sledgehammer |
| 4. acahwks | hacksaw |
| 5. dlrl bist | drill bits |
| 6. tinap rreol | paint roller |
| 7. ibnshpurta | paintbrush |
| 8. ilfe | file |
| 9. ncawihsa | chainsaw |
| 10. ihlcse | chisel |
| 11. ssgal tucert | glass cutter |
| 12. gnnridgi eanicmh | grinding machine |
| 13. oloxtob | toolbox |
| 14. lpaset ugn | staple gun |
| 15. drnogseil onir | soldering iron |
| 16. thoroclbw | blowtorch |

